

National Flood Insurance Program

Elevation Certificate and Instructions

2022 EDITION



FEMA

ELEVATION CERTIFICATE AND INSTRUCTIONS

PAPERWORK REDUCTION ACT NOTICE

Public reporting burden for this data collection is estimated to average 3.75 hours per response. The burden estimate includes the time for reviewing instructions, searching existing data sources, gathering and maintaining the data needed, and completing and submitting this form. You are not required to respond to this collection of information unless a valid OMB control number is displayed on this form. Send comments regarding the accuracy of the burden estimate and any suggestions for reducing the burden to: Information Collections Management, Department of Homeland Security, Federal Emergency Management Agency, 500 C Street SW, Washington, DC 20742, Paperwork Reduction Project (1660-0008). **NOTE: Do not send your completed form to this address.**

PRIVACY ACT STATEMENT

Authority: Title 44 CFR § 61.7 and 61.8.

Principal Purpose(s): This information is being collected for the primary purpose of documenting compliance with National Flood Insurance Program (NFIP) floodplain management ordinances for new or substantially improved structures in designated Special Flood Hazard Areas. This form may also be used as an optional tool for a Letter of Map Amendment (LOMA), Conditional LOMA (CLOMA), Letter of Map Revision Based on Fill (LOMR-F), or Conditional LOMR-F (CLOMR-F), or for flood insurance rating purposes in any flood zone.

Routine Use(s): The information on this form may be disclosed as generally permitted under 5 U.S.C. § 552a(b) of the Privacy Act of 1974, as amended. This includes using this information as necessary and authorized by the routine uses published in DHS/ FEMA-003 – *National Flood Insurance Program Files System of Records Notice 79* Fed. Reg. 28747 (May 19, 2014) and upon written request, written consent, by agreement, or as required by law.

Disclosure: The disclosure of information on this form is voluntary; however, failure to provide the information requested may impact the flood insurance premium through the NFIP. Information will only be released as permitted by law.

PURPOSE OF THE ELEVATION CERTIFICATE

The Elevation Certificate is an important administrative tool of the NFIP. It can be used to provide elevation information necessary to ensure compliance with community floodplain management ordinances, to inform the proper insurance premium, and to support a request for a LOMA, CLOMA, LOMR-F, or CLOMR-F.

The Elevation Certificate is used to document floodplain management compliance for Post-Flood Insurance Rate Map (FIRM) buildings, which are buildings constructed after publication of the FIRM, located in flood Zones A1–A30, AE, AH, AO, A (with Base Flood Elevation (BFE)), VE, V1–V30, V (with BFE), AR, AR/A, AR/AE, AR/A1–A30, AR/AH, AR/AO, and A99. It may also be used to provide elevation information for Pre-FIRM buildings or buildings in any flood zone.

As part of the agreement for making flood insurance available in a community, the NFIP requires the community to adopt floodplain management regulations that specify minimum requirements for reducing flood losses. One such requirement is for the community to obtain the elevation of the lowest floor (including basement) of all new and substantially improved buildings, and maintain a record of such information. The Elevation Certificate provides a way for a community to document compliance with the community's floodplain management ordinance.

Use of this certificate does not provide a waiver of the flood insurance purchase requirement. Only a LOMA or LOMR-F from the Federal Emergency Management Agency (FEMA) can amend the FIRM and remove the federal mandate for a lending institution to require the purchase of flood insurance. However, the lending institution has the option of requiring flood insurance even if a LOMA/LOMR-F has been issued by FEMA. The Elevation Certificate may be used to support a LOMA, CLOMA, LOMR-F, or CLOMR-F request. Lowest Adjacent Grade (LAG) elevations certified by a land surveyor, engineer, or architect, as authorized by state law, will be required if the certificate is used to support a LOMA, CLOMA, LOMR-F, or CLOMR-F request. A LOMA, CLOMA, LOMR-F, or CLOMR-F request must be submitted with either a completed FEMA MT-EZ or MT-1 application package, whichever is appropriate. If the certificate will only be completed to support a LOMA, CLOMA, LOMR-F, or CLOMR-F request, there is an option to document the certified LAG elevation on the Elevation Form included in the MT-EZ and MT-1 application.

This certificate is used only to certify building elevations. A separate certificate is required for floodproofing. Under the NFIP, non-residential buildings can be floodproofed up to or above the BFE. A floodproofed building is a building that has been designed and constructed to be watertight (substantially impermeable to floodwaters) below the BFE. Floodproofing of residential buildings is not permitted under the NFIP unless FEMA has granted the community an exception for residential floodproofed basements. The community must adopt standards for design and construction of floodproofed basements before FEMA will grant a basement exception. For both floodproofed non-residential buildings and residential floodproofed basements in communities that have been granted an exception by FEMA, a floodproofing certificate is required.

The expiration date on the form herein does not apply to certified and completed Elevation Certificates, as a completed Elevation Certificate does not expire, unless there is a physical change to the building that invalidates information in Section A Items A8 or A9, Section C, Section E, or Section H. In addition, this form is intended for the specific building referenced in Section A and is not invalidated by the transfer of building ownership.

Additional guidance can be found in FEMA Publication 467-1, *Floodplain Management Bulletin: Elevation Certificate*.

ELEVATION CERTIFICATE

IMPORTANT: MUST FOLLOW THE INSTRUCTIONS ON PAGES 9-19

Copy all pages of this Elevation Certificate and all attachments for (1) community official, (2) insurance agent/company, and (3) building owner.

SECTION A – PROPERTY INFORMATION	FOR INSURANCE COMPANY USE
A1. Building Owner's Name: _____	Policy Number: _____
A2. Building Street Address (including Apt., Unit, Suite, and/or Bldg. No.) or P.O. Route and Box No.: _____	Company NAIC Number: _____
City: _____ State: _____ ZIP Code: _____	
A3. Property Description (e.g., Lot and Block Numbers or Legal Description) and/or Tax Parcel Number: _____	
A4. Building Use (e.g., Residential, Non-Residential, Addition, Accessory, etc.): _____	
A5. Latitude/Longitude: Lat. _____ Long. _____ Horizontal Datum: <input type="checkbox"/> NAD 1927 <input type="checkbox"/> NAD 1983 <input type="checkbox"/> WGS 84	
A6. Attach at least two and when possible four clear photographs (one for each side) of the building (see Form pages 7 and 8).	
A7. Building Diagram Number: _____	
A8. For a building with a crawlspace or enclosure(s):	
a) Square footage of crawlspace or enclosure(s): _____ sq. ft.	
b) Is there at least one permanent flood opening on two different sides of each enclosed area? <input type="checkbox"/> Yes <input type="checkbox"/> No <input type="checkbox"/> N/A	
c) Enter number of permanent flood openings in the crawlspace or enclosure(s) within 1.0 foot above adjacent grade: Non-engineered flood openings: _____ Engineered flood openings: _____	
d) Total net open area of non-engineered flood openings in A8.c: _____ sq. in.	
e) Total rated area of engineered flood openings in A8.c (attach documentation – see Instructions): _____ sq. ft.	
f) Sum of A8.d and A8.e rated area (if applicable – see Instructions): _____ sq. ft.	
A9. For a building with an attached garage:	
a) Square footage of attached garage: _____ sq. ft.	
b) Is there at least one permanent flood opening on two different sides of the attached garage? <input type="checkbox"/> Yes <input type="checkbox"/> No <input type="checkbox"/> N/A	
c) Enter number of permanent flood openings in the attached garage within 1.0 foot above adjacent grade: Non-engineered flood openings: _____ Engineered flood openings: _____	
d) Total net open area of non-engineered flood openings in A9.c: _____ sq. in.	
e) Total rated area of engineered flood openings in A9.c (attach documentation – see Instructions): _____ sq. ft.	
f) Sum of A9.d and A9.e rated area (if applicable – see Instructions): _____ sq. ft.	

SECTION B – FLOOD INSURANCE RATE MAP (FIRM) INFORMATION

B1.a. NFIP Community Name: _____	B1.b. NFIP Community Identification Number: _____
B2. County Name: _____	B3. State: _____
B4. Map/Panel No.: _____	B5. Suffix: _____
B6. FIRM Index Date: _____	B7. FIRM Panel Effective/Revised Date: _____
B8. Flood Zone(s): _____	
B9. Base Flood Elevation(s) (BFE) (Zone AO, use Base Flood Depth): _____	
B10. Indicate the source of the BFE data or Base Flood Depth entered in Item B9: <input type="checkbox"/> FIS <input type="checkbox"/> FIRM <input type="checkbox"/> Community Determined <input type="checkbox"/> Other: _____	
B11. Indicate elevation datum used for BFE in Item B9: <input type="checkbox"/> NGVD 1929 <input type="checkbox"/> NAVD 1988 <input type="checkbox"/> Other/Source: _____	
B12. Is the building located in a Coastal Barrier Resources System (CBRS) area or Otherwise Protected Area (OPA)? <input type="checkbox"/> Yes <input type="checkbox"/> No Designation Date: _____ <input type="checkbox"/> CBRS <input type="checkbox"/> OPA	
B13. Is the building located seaward of the Limit of Moderate Wave Action (LiMWA)? <input type="checkbox"/> Yes <input type="checkbox"/> No	

ELEVATION CERTIFICATE

IMPORTANT: MUST FOLLOW THE INSTRUCTIONS ON PAGES 9-19

Building Street Address (including Apt., Unit, Suite, and/or Bldg. No.) or P.O. Route and Box No.:

City: _____ State: _____ ZIP Code: _____

FOR INSURANCE COMPANY USE

Policy Number: _____

Company NAIC Number: _____

SECTION C – BUILDING ELEVATION INFORMATION (SURVEY REQUIRED)

C1. Building elevations are based on: Construction Drawings* Building Under Construction* Finished Construction

*A new Elevation Certificate will be required when construction of the building is complete.

C2. Elevations – Zones A1–A30, AE, AH, AO, A (with BFE), VE, V1–V30, V (with BFE), AR, AR/A, AR/AE, AR/A1–A30, AR/AH, AR/AO, A99. Complete Items C2.a–h below according to the Building Diagram specified in Item A7. In Puerto Rico only, enter meters.

Benchmark Utilized: _____ Vertical Datum: _____

Indicate elevation datum used for the elevations in items a) through h) below.

NGVD 1929 NAVD 1988 Other: _____

Datum used for building elevations must be the same as that used for the BFE. Conversion factor used? Yes No

If Yes, describe the source of the conversion factor in the Section D Comments area.

Check the measurement used:

a) Top of bottom floor (including basement, crawlspace, or enclosure floor): _____ feet meters

b) Top of the next higher floor (see Instructions): _____ feet meters

c) Bottom of the lowest horizontal structural member (see Instructions): _____ feet meters

d) Attached garage (top of slab): _____ feet meters

e) Lowest elevation of Machinery and Equipment (M&E) servicing the building (describe type of M&E and location in Section D Comments area): _____ feet meters

f) Lowest Adjacent Grade (LAG) next to building: Natural Finished _____ feet meters

g) Highest Adjacent Grade (HAG) next to building: Natural Finished _____ feet meters

h) Finished LAG at lowest elevation of attached deck or stairs, including structural support: _____ feet meters

SECTION D – SURVEYOR, ENGINEER, OR ARCHITECT CERTIFICATION

This certification is to be signed and sealed by a land surveyor, engineer, or architect authorized by state law to certify elevation information. *I certify that the information on this Certificate represents my best efforts to interpret the data available. I understand that any false statement may be punishable by fine or imprisonment under 18 U.S. Code, Section 1001.*

Were latitude and longitude in Section A provided by a licensed land surveyor? Yes No

Check here if attachments and describe in the Comments area.

Certifier's Name: _____ License Number: _____

Title: _____

Company Name: _____

Address: _____

City: _____ State: _____ ZIP Code: _____

Signature: _____ Date: _____

Telephone: _____ Ext.: _____ Email: _____

Place Seal Here

Copy all pages of this Elevation Certificate and all attachments for (1) community official, (2) insurance agent/company, and (3) building owner.

Comments (including source of conversion factor in C2; type of equipment and location per C2.e; and description of any attachments):

ELEVATION CERTIFICATE

IMPORTANT: MUST FOLLOW THE INSTRUCTIONS ON PAGES 9-19

Building Street Address (including Apt., Unit, Suite, and/or Bldg. No.) or P.O. Route and Box No.:

FOR INSURANCE COMPANY USE

City: _____ State: _____ ZIP Code: _____

Policy Number: _____

Company NAIC Number: _____

SECTION E – BUILDING MEASUREMENT INFORMATION (SURVEY NOT REQUIRED) FOR ZONE AO, ZONE AR/AO, AND ZONE A (WITHOUT BFE)

For Zones AO, AR/AO, and A (without BFE), complete Items E1–E5. For Items E1–E4, use natural grade, if available. If the Certificate is intended to support a Letter of Map Change request, complete Sections A, B, and C. Check the measurement used. In Puerto Rico only, enter meters.

Building measurements are based on: Construction Drawings* Building Under Construction* Finished Construction

*A new Elevation Certificate will be required when construction of the building is complete.

E1. Provide measurements (C.2.a in applicable Building Diagram) for the following and check the appropriate boxes to show whether the measurement is above or below the natural HAG and the LAG.

a) Top of bottom floor (including basement, crawlspace, or enclosure) is: _____ feet meters above or below the HAG.

b) Top of bottom floor (including basement, crawlspace, or enclosure) is: _____ feet meters above or below the LAG.

E2. For Building Diagrams 6–9 with permanent flood openings provided in Section A Items 8 and/or 9 (see pages 1–2 of Instructions), the next higher floor (C2.b in applicable Building Diagram) of the building is: _____ feet meters above or below the HAG.

E3. Attached garage (top of slab) is: _____ feet meters above or below the HAG.

E4. Top of platform of machinery and/or equipment servicing the building is: _____ feet meters above or below the HAG.

E5. Zone AO only: If no flood depth number is available, is the top of the bottom floor elevated in accordance with the community's floodplain management ordinance? Yes No Unknown The local official must certify this information in Section G.

SECTION F – PROPERTY OWNER (OR OWNER'S AUTHORIZED REPRESENTATIVE) CERTIFICATION

The property owner or owner's authorized representative who completes Sections A, B, and E for Zone A (without BFE) or Zone AO must sign here. *The statements in Sections A, B, and E are correct to the best of my knowledge*

Check here if attachments and describe in the Comments area.

Property Owner or Owner's Authorized Representative Name: _____

Address: _____

City: _____ State: _____ ZIP Code: _____

Signature: _____ Date: _____

Telephone: _____ Ext.: _____ Email: _____

Comments: _____

ELEVATION CERTIFICATE

IMPORTANT: MUST FOLLOW THE INSTRUCTIONS ON PAGES 9-19

Building Street Address (including Apt., Unit, Suite, and/or Bldg. No.) or P.O. Route and Box No.:

City: _____ State: _____ ZIP Code: _____

FOR INSURANCE COMPANY USE

Policy Number: _____

Company NAIC Number: _____

SECTION G – COMMUNITY INFORMATION (RECOMMENDED FOR COMMUNITY OFFICIAL COMPLETION)

The local official who is authorized by law or ordinance to administer the community's floodplain management ordinance can complete Section A, B, C, E, G, or H of this Elevation Certificate. Complete the applicable item(s) and sign below when:

- G1. The information in Section C was taken from other documentation that has been signed and sealed by a licensed surveyor, engineer, or architect who is authorized by state law to certify elevation information. (Indicate the source and date of the elevation data in the Comments area below.)
- G2.a. A local official completed Section E for a building located in Zone A (without a BFE), Zone AO, or Zone AR/AO, or when item E5 is completed for a building located in Zone AO.
- G2.b. A local official completed Section H for insurance purposes.
- G3. In the Comments area of Section G, the local official describes specific corrections to the information in Sections A, B, E and H.
- G4. The following information (Items G5–G11) is provided for community floodplain management purposes.
- G5. Permit Number: _____ G6. Date Permit Issued: _____
- G7. Date Certificate of Compliance/Occupancy Issued: _____
- G8. This permit has been issued for: New Construction Substantial Improvement
- G9.a. Elevation of as-built lowest floor (including basement) of the building: _____ feet meters Datum: _____
- G9.b. Elevation of bottom of as-built lowest horizontal structural member: _____ feet meters Datum: _____
- G10.a. BFE (or depth in Zone AO) of flooding at the building site: _____ feet meters Datum: _____
- G10.b. Community's minimum elevation (or depth in Zone AO) requirement for the lowest floor or lowest horizontal structural member: _____ feet meters Datum: _____
- G11. Variance issued? Yes No If yes, attach documentation and describe in the Comments area.

The local official who provides information in Section G must sign here. *I have completed the information in Section G and certify that it is correct to the best of my knowledge. If applicable, I have also provided specific corrections in the Comments area of this section.*

Local Official's Name: _____ Title: _____

NFIP Community Name: _____

Telephone: _____ Ext.: _____ Email: _____

Address: _____

City: _____ State: _____ ZIP Code: _____

Signature: _____ Date: _____

Comments (including type of equipment and location, per C2.e; description of any attachments; and corrections to specific information in Sections A, B, D, E, or H):

ELEVATION CERTIFICATE

IMPORTANT: MUST FOLLOW THE INSTRUCTIONS ON PAGES 9-19

Building Street Address (including Apt., Unit, Suite, and/or Bldg. No.) or P.O. Route and Box No.:

FOR INSURANCE COMPANY USE

City: _____ State: _____ ZIP Code: _____

Policy Number: _____

Company NAIC Number: _____

SECTION H – BUILDING'S FIRST FLOOR HEIGHT INFORMATION FOR ALL ZONES (SURVEY NOT REQUIRED) (FOR INSURANCE PURPOSES ONLY)

The property owner, owner's authorized representative, or local floodplain management official may complete Section H for all flood zones to determine the building's first floor height for insurance purposes. Sections A, B, and I must also be completed. Enter heights to the nearest tenth of a foot (nearest tenth of a meter in Puerto Rico). **Reference the Foundation Type Diagrams (at the end of Section H Instructions) and the appropriate Building Diagrams (at the end of Section I Instructions) to complete this section.**

H1. Provide the height of the top of the floor (as indicated in Foundation Type Diagrams) above the Lowest Adjacent Grade (LAG):

a) **For Building Diagrams 1A, 1B, 3, and 5–9.** Top of bottom _____ feet meters above the LAG floor (include above-grade floors only for buildings with subgrade crawlspaces or enclosure floors) is:

b) **For Building Diagrams 2A, 2B, 4, and 6–9.** Top of next higher floor (i.e., the floor above basement, crawlspace, or enclosure floor) is: _____ feet meters above the LAG

H2. Is **all** Machinery and Equipment servicing the building (as listed in Item H2 instructions) elevated to or above the floor indicated by the H2 arrow (shown in the Foundation Type Diagrams at end of Section H instructions) for the appropriate Building Diagram?

Yes No

SECTION I – PROPERTY OWNER (OR OWNER'S AUTHORIZED REPRESENTATIVE) CERTIFICATION

The property owner or owner's authorized representative who completes Sections A, B, and H must sign here. *The statements in Sections A, B, and H are correct to the best of my knowledge.* **Note:** If the local floodplain management official completed Section H, they should indicate in Item G2.b and sign Section G.

Check here if attachments are provided (including required photos) and describe each attachment in the Comments area.

Property Owner or Owner's Authorized Representative Name: _____

Address: _____

City: _____ State: _____ ZIP Code: _____

Signature: _____ Date: _____

Telephone: _____ Ext.: _____ Email: _____

Comments:

ELEVATION CERTIFICATE
IMPORTANT: MUST FOLLOW THE INSTRUCTIONS ON PAGES 9-19
BUILDING PHOTOGRAPHS

See Instructions for Item A6.

Building Street Address (including Apt., Unit, Suite, and/or Bldg. No.) or P.O. Route and Box No.:

City: _____ State: _____ ZIP Code: _____

FOR INSURANCE COMPANY USE

Policy Number: _____

Company NAIC Number: _____

Instructions: Insert below at least two and when possible four photographs showing each side of the building (for example, may only be able to take front and back pictures of townhouses/rowhouses). Identify all photographs with the date taken and "Front View," "Rear View," "Right Side View," or "Left Side View." Photographs must show the foundation. When flood openings are present, include at least one close-up photograph of representative flood openings or vents, as indicated in Sections A8 and A9.

Photo One

Photo One Caption:

Clear Photo One

Photo Two

Photo Two Caption:

Clear Photo Two

ELEVATION CERTIFICATE
IMPORTANT: MUST FOLLOW THE INSTRUCTIONS ON PAGES 9-19
BUILDING PHOTOGRAPHS

Continuation Page

Building Street Address (including Apt., Unit, Suite, and/or Bldg. No.) or P.O. Route and Box No.:

City: _____ State: _____ ZIP Code: _____

FOR INSURANCE COMPANY USE

Policy Number: _____

Company NAIC Number: _____

Insert the third and fourth photographs below. Identify all photographs with the date taken and "Front View," "Rear View," "Right Side View," or "Left Side View." When flood openings are present, include at least one close-up photograph of representative flood openings or vents, as indicated in Sections A8 and A9.

Photo Three

Photo Three Caption:

Clear Photo Three

Photo Four

Photo Four Caption:

Clear Photo Four

DEPARTMENT OF HOMELAND SECURITY
Federal Emergency Management Agency

INSTRUCTIONS FOR COMPLETING THE ELEVATION CERTIFICATE

The Elevation Certificate is to be completed by a land surveyor, engineer, or architect who is authorized by state law to certify elevation information when elevation information is required or used for Zones A1–A30, AE, AH, AO, A (with Base Flood Elevation (BFE)), VE, V1–V30, V (with BFE), AR, AR/A, AR/AE, AR/A1–A30, AR/AH, AR/AO, or A99.

Community officials who are authorized by law or ordinance to provide floodplain management information (herein referred to as “local floodplain management official”) may also complete this form. For Zones AO, AR/AO, and A (without BFE), a local floodplain management official, a property owner, or an owner’s authorized representative may provide floodplain management compliance information on this certificate in Section E, unless the elevations are intended for use in supporting a request for a LOMA, CLOMA, LOMR-F, or CLOMR-F. Certified elevations must be included if the purpose of completing the Elevation Certificate is to obtain a LOMA, CLOMA, LOMR-F, or CLOMR-F.

The property owner, the owner’s authorized representative, or local floodplain management official can complete Section A and Section B. The partially completed form can then be given to the land surveyor, engineer, or architect to complete Section C. The land surveyor, engineer, or architect should verify the information provided by the property owner or owner’s representative to ensure that this certificate is complete.

For insurance purposes only, a local floodplain management official, a property owner, or an owner’s authorized representative may provide First Floor Height details in Section H for any zone.

In Puerto Rico only, elevations for building information and flood hazard information may be entered in meters.

Note: Section C can be used for insurance and compliance in any zone; however, Section E can be used only for compliance in Zone AO and Zone A.

SECTION A – PROPERTY INFORMATION

Items A1–A4. This section identifies the building, its location, and its owner. Enter the name(s) of the building owner(s), the building’s complete street address or property description (e.g., lot and block numbers or legal description), and/or tax parcel number. If the building’s address is different from the owner’s address, enter the address of the building being certified. If the address is a rural route or a Post Office box number, enter the lot and block numbers, the tax parcel number, the legal description, or an abbreviated location description based on distance and direction from a fixed point of reference. For the purposes of this certificate, “building” means both a building and a manufactured (mobile) home. For properties with multiple buildings, include a description for the specific building.

A map may be attached to this certificate to show the location of the building on the property. A tax map, Flood Insurance Rate Map (FIRM), or detailed community map is appropriate. If no map is available, provide a sketch of the property location, and the location of the building on the property. Include appropriate landmarks such as nearby roads, intersections, and bodies of water. For building use, indicate whether the building is residential, non-residential, an addition to an existing residential or non-residential building, an accessory building (e.g., garage), or other type of structure. Use the Comments area of the appropriate section if needed, or attach additional comments.

Item A5. Provide latitude and longitude coordinates for the center of the front of the building. Use either decimal degrees (e.g., 39.504322°, –110.758522°) or degrees, minutes, seconds (e.g., 39° 30’ 15.56”, –110° 45’ 30.68”) format. If decimal degrees are used, provide coordinates to at least six decimal places or better. When using degrees, minutes, seconds, provide seconds to at least two decimal places or better. Provide the datum of the latitude and longitude coordinates (FEMA prefers the use of NAD 1983). Indicate the method or source used to determine the latitude and longitude in the Comments area of the appropriate section. When the latitude and longitude are provided by a land surveyor, check the “Yes” box in Section D.

Item A6. The certifier must provide at least two and when possible four photographs showing each side of the building taken within 90 days from the date of certification. The photographs must be taken with views confirming the building description and Building Diagram number provided in Item A7. To the extent possible, these photographs should show the entire building including foundation. In addition, when applicable, provide a photograph of the foundation showing a representative example of the flood openings or vents. All photographs must be in color and measure at least 3”x3”. Digital photographs are acceptable. Additional photographs may be requested by local floodplain management officials or for insurance purposes to show additional detail regarding the building characteristics or features.

Item A7. Select the Building Diagram (shown on pages 17-19) that best represents the building. Then enter the diagram number and use the diagram to identify and determine the appropriate elevations requested in Items C2.a–h. If you are unsure of the correct diagram, select the diagram that most closely resembles the building being certified.

Item A8.a. Provide the square footage of the crawlspace or enclosure(s) below the lowest elevated floor of an elevated building with or without permanent flood openings. Take the measurement from the outside of the crawlspace or enclosure(s). Examples of elevated buildings constructed with crawlspace and enclosure(s) are shown in Diagrams 6-9 on pages 18-19. Diagram 2A, 2B, 4, or 9 should be used for a building constructed with a crawlspace floor that is below the exterior grade on all sides. If there is no crawlspace or enclosure, enter “N/A” for Items A8.a-f.

Item A8.b. Indicate if there is at least one permanent flood opening within 1.0 foot of the adjacent grade on at least two exterior walls of each enclosed area identified in A8.a. A permanent flood opening is a flood vent or other opening that allows the free passage of water automatically in both directions without human intervention. If the crawlspace or enclosure(s) have no permanent flood openings, or if none of the openings are within 1.0 foot above adjacent grade, enter “0” (zero) in Item A8.c-f. If there is no crawlspace or enclosure, enter “N/A”.

SECTION A – PROPERTY INFORMATION (Continued)

Item A8.c. Enter the total number of permanent non-engineered and/or engineered flood openings in the crawlspace or enclosure(s) that are no higher than 1.0 foot above the higher of the exterior or interior grade or floor immediately below the opening. If the interior grade elevation is used, note this in the Comments area of Section D.

Item A8.d. Enter the total measured net open area of permanent non-engineered flood openings indicated in A8.c in square inches, excluding any bars, louvers, or other covers of the permanent flood openings. Non-engineered openings that meet the requirements of NFIP Technical Bulletin 1 are assumed to provide one square foot of rated area for each square inch of net open area. If the net open area cannot be measured, provide in the Comments area of the appropriate section the size of the flood openings without consideration of any covers and indicate the type of cover that exists in the flood openings.

Item A8.e. Enter the total rated area of the permanent engineered flood openings indicated in A8.c, in square feet. Attach a copy of the Individual Engineered Flood Openings Certification for a specific building or an Evaluation Report issued by the International Code Council Evaluation Service (ICC ES) for all engineered openings, and indicate the manufacturer's name and model number in the Comments area of the appropriate section, if applicable. Flood openings cannot be considered engineered flood openings without documentation. If no documentation is available/provided, enter the net open (unobstructed) area of the flood openings in A8.d instead.

Item A8.f. Complete only if permanent engineered and permanent non-engineered flood openings are both present. Enter the sum of A8.d (net open area of all non-engineered openings) and A8.e (total rated area of all engineered openings). Non-engineered openings that meet the requirements of NFIP Technical Bulletin 1 are assumed to provide one square foot of rated area for each square inch of net open area. For example, a non-engineered opening with 140 sq. in. of net open area (i.e., rated for 140 sq. ft. of enclosure area), combined with two (2) engineered openings rated for 200 sq. ft. each, would yield $140 + 400 = 540$ sq. ft. rated area. If either A8.d or A8.e is "0", then enter "N/A" for A8.f.

Item A9.a. Provide the square footage of the attached garage with or without permanent flood openings. Take the measurement from the outside of the garage. If there is no attached garage, enter "N/A" for items A9.a-f.

Item A9.b. Indicate if there is at least one permanent flood opening within 1.0 foot of the adjacent grade on at least two exterior walls of the attached garage identified in A9.a. If the attached garage has no permanent flood openings, or if none of the openings are within 1.0 foot above adjacent grade, enter "0" (zero) in Items A9.c-f. If there is no attached garage, enter "N/A".

Item A9.c. Enter the total number of permanent non-engineered and/or engineered flood openings in the attached garage that are no higher than 1.0 foot above the higher of the exterior or interior grade or floor immediately below the opening. This includes any openings that are in the garage door that are no higher than 1.0 foot above the adjacent grade. If the interior grade elevation is used, note this in the Comments area of Section D.

Item A9.d. Enter the total measured net open area of permanent non-engineered flood openings indicated in A9.c in square inches, excluding any bars, louvers, or other covers of the permanent flood openings, and enter the total in Item A9.d. Non-engineered openings that meet the requirements of NFIP Technical Bulletin 1 are assumed to provide one square foot of rated area for each square inch of net open area. If the net open area cannot be measured, provide in the Comments area of the appropriate section the size of the flood openings without consideration of any covers and indicate the type of cover that exists in the flood openings.

Item A9.e. Enter the total rated area of the permanent engineered flood openings indicated in A9.c in square feet. Attach a copy of the Individual Engineered Flood Openings Certification for a specific building or an Evaluation Report issued by the ICC ES for all engineered openings, and indicate the manufacturer's name and model number in the Comments area of the appropriate section, if applicable. Flood openings cannot be considered engineered flood openings without documentation. If no documentation is available/provided, enter the net open (unobstructed) area of the flood openings in A9.d instead.

Item A9.f. Complete only if permanent engineered and permanent non-engineered flood openings are both present. Enter the sum of A9.d (net open area of all non-engineered openings) and A9.e (total rated area of all engineered openings). Non-engineered openings that meet the requirements of NFIP Technical Bulletin 1 are assumed to provide one square foot of rated area for each square inch of net open area. For example, a non-engineered opening with 140 sq. in. of net open area (i.e., rated for 140 sq. ft. of enclosure area), combined with two (2) engineered openings rated for 200 sq. ft. each, would yield $140 + 400 = 540$ sq. ft. rated area. If either A9.d or A9.e is "0", then enter "N/A" for A9.f.

SECTION B – FLOOD INSURANCE RATE MAP (FIRM) INFORMATION

Complete the Elevation Certificate using the Flood Insurance Study (FIS) and FIRM in effect at the time of the certification.

The information for Section B is obtained by reviewing the FIS and the FIRM panel that includes the building's location. Information about the current FIS and FIRM is available from FEMA by visiting [msc.fema.gov](https://www.msc.fema.gov) or contacting the local floodplain management official. If a Letter of Map Amendment (LOMA), Letter of Map Revision Based on Fill (LOMR-F), or Letter of Map Revision (LOMR) has been issued by FEMA, please provide the letter date and case number in the Comments area of Section D or Section G, as appropriate.

For a building in an area that was mapped in one community but is now in another community due to annexation or dissolution, enter the community name and six-digit Community Identification Number of the community in which the building is now located in Items B1.a and B1.b; the name of the county or new county, if necessary, in Item B2; and the FIRM index date for the community identified in B1.a, in Item B6. Enter information from the actual FIRM panel that shows the building location, even if it is the FIRM for the previous jurisdiction, in Items B4, B5, B7, B8, and B9.

If the map in effect at the time of the building's construction was other than the current FIRM, and you have the past map information pertaining to the building, provide the information in the Comments area of Section D.

Note: Indicate in the Comments area of Section D if using information based on best available data, such as base-level engineering or advisory flood hazard data (contact the local floodplain management official to confirm).

SECTION B – FLOOD INSURANCE RATE MAP (FIRM) INFORMATION (Continued)

Items B1.a–b NFIP Community Name and Community Identification Number. Enter the complete name of the community in which the building is located in B1.a, and the associated six-digit Community Identification Number in B1.b. For an unincorporated area of a county, enter the county name and “unincorporated area”, and the six-digit number of the county. For a newly incorporated community, use the name and six-digit number of the new community. Under the NFIP, a “community” is any state or area or political subdivision thereof, or any Indian tribe or authorized native organization which has authority to adopt and enforce floodplain management regulations for the areas within its jurisdiction. To determine the current community number, see the NFIP *Community Status Book*, available on FEMA's website at www.fema.gov/national-flood-insurance-program-community-status-book.

Item B2. County Name. Enter the name of the county or counties in which the community is located. For an unincorporated area of a county, enter the county name. For an independent city, enter “independent city.”

Item B3. State. Enter the two-letter state abbreviation (for example, VA, TX, CA).

Items B4–B5. Map/Panel Number and Suffix. Enter the 10-character “Map Number” or “Community Panel Number” shown on the FIRM where the building or manufactured (mobile) home is located. For maps in a county-wide format, the sixth character of the “Map Number” is the letter “C” followed by a four-digit map number. For maps not in a county-wide format, enter the “Community Panel Number” shown on the FIRM.

Item B6. FIRM Index Date. Enter the effective date or the map revised date shown on the FIRM Index.

Item B7. FIRM Panel Effective/Revised Date. Enter the effective date shown on the current FIRM panel. The current FIRM panel effective date can be determined by visiting msc.fema.gov or contacting the local floodplain management official. If the area where the building is located was revised by a LOMR, include the LOMR effective date and the LOMR case number in the comments area of Section D.

Item B8. Flood Zone(s). Enter the flood zone, or flood zones, in which the building is located. All flood zones containing the letter “A” or “V” are considered Special Flood Hazard Areas (SFHAs). Each flood zone is defined in the legend of the FIRM panel on which it appears. If the area where the building is located was revised by a LOMA, CLOMA, LOMR-F, or CLOMR-F, include the flood zone shown on the LOMA, CLOMA, LOMR-F, or CLOMR-F, and add the effective date and case number in the comments area of Section D.

Item B9. Base Flood Elevation(s) (BFE). Using the appropriate Flood Insurance Study (FIS) Profile, FIS Data Table (e.g. Transect, Floodway, etc.), or FIRM panel, locate the property and enter the BFE (or base flood depth) of the building site to the nearest tenth of a foot (nearest tenth of a meter, in Puerto Rico). If the building is located in more than one flood zone in Item B8, list all appropriate BFEs in Item B9.

BFEs are shown in the FIS or on a FIRM for Zones A1–A30, AE, AH, V1–V30, VE, AR, AR/A, AR/AE, AR/A1–A30, and AR/AH; base flood depths are shown for Zones AO and AR/AO. Use the AR BFE (or base flood depth) if the building is located in any of these zones: AR/A, AR/AE, AR/A1–A30, AR/AH, or AR/AO.

In A or V zones where BFEs are not provided in the FIS or on the FIRM, BFEs may be available from another source. For example, the community may have established BFEs or obtained BFE data from other sources (e.g., Base Level Engineering) for the building site. For subdivisions and other developments of more than 50 lots or 5 acres in Zone A, establishment of BFEs is required by the community's floodplain management ordinance. If a BFE is obtained from another source, enter the BFE in Item B9. The BFE entered in Item B9 must be based on hydrologic and hydraulic analyses. In an A Zone where BFEs are not obtained from another source, enter N/A in Item B9 and complete Section E.

Item B10. Indicate the source of the BFE or base flood depth that you entered in Item B9. If the BFE is from a source other than the FIS, FIRM, or community, include the name of the study, the agency or company that produced it, and the date when the study was completed. Visit msc.fema.gov or contact the local floodplain management official to access the current FIS and FIRM.

Item B11. Indicate the elevation datum to which the elevations on the applicable FIRM are referenced as shown on the map legend. The vertical datum is shown in the Map Legend and/or the Notes to Users on the FIRM.

Item B12. Indicate whether the building is located in a Coastal Barrier Resources System (CBRS) area or Otherwise Protected Area (OPA). OPAs are portions of coastal barriers that are owned by Federal, State, or local governments or by certain non-profit organizations and used primarily for natural resources protection. CBRS areas and OPAs are no longer shown on the FIRM; please use the maps available at www.fws.gov/cbra/maps/index.html to complete Item B12. Federal flood insurance is prohibited in designated CBRS areas or OPAs for buildings or manufactured (mobile) homes built or substantially improved after the date of the CBRS or OPA designation. For the first CBRS designations, that date is October 1, 1983. Information about CBRS areas and OPAs may be obtained on the FEMA website at www.fema.gov/national-flood-insurance-program/coastal-barrier-resources-system.

Item B13. Indicate whether the building is located seaward of the Limit of Moderate Wave Action (LiMWA). If the LiMWA is not shown on the FIRM, check the “No” box. Information about the LiMWA and other coastal flood zones may be obtained on the FEMA website at www.fema.gov/flood-maps/coastal/insurance-rate-maps.

SECTION C – BUILDING ELEVATION INFORMATION (SURVEY REQUIRED)

Complete Section C if the building is located in any of Zones A1–A30, AE, AH, A (with BFE), VE, V1–V30, V (with BFE), AR, AR/A, AR/AE, AR/A1–A30, AR/AH, or A99. If the Certificate is being completed to demonstrate compliance with local floodplain management requirements, contact the local floodplain management official to find out any additional requirements. Section C may also be completed for insurance purposes to determine the building's First Floor Height in any flood zone (including Zones AO, AR/AO, B, C, X and D). In addition, complete Section C if this certificate is being used to support a request for a LOMA, CLOMA, LOMR-F, or CLOMR-F.

To ensure that all required elevations are obtained, it may be necessary to physically enter the building (for instance, if the building has a basement or sunken living room, split-level construction, or Machinery and Equipment (M&E)).

SECTION C – BUILDING ELEVATION INFORMATION (SURVEY REQUIRED) (Continued)

Land surveyors may not be able to gain access to some crawlspaces to shoot the elevation of the crawlspace floor. If access to the crawlspace is limited or cannot be gained, follow one of these procedures.

- Use a yardstick or tape measure to measure the height from the floor of the crawlspace to the "next higher floor," and then subtract the crawlspace height from the elevation of the "next higher floor." If there is no access to the crawlspace, use the exterior grade next to the structure to measure the height of the crawlspace to the "next higher floor."
- Contact the local floodplain management official of the community in which the building is located. The community may have documentation of the elevation of the crawlspace floor as part of the permit issued for the building.
- If the property owner has documentation or knows the height of the crawlspace floor to the next higher floor, try to verify this by looking inside the crawlspace through any openings or vents.

In all three cases, use the Comments area of Section D to provide the elevation and a brief description of how the elevation was obtained.

Note: If any item does not apply to the building, enter "N/A" for not applicable.

Item C1. Indicate whether the elevations to be entered in this section are based on construction drawings, a building under construction, or finished construction. For either of the first two choices, a post-construction Elevation Certificate will be required when construction is complete. If the building is under construction, include only those elevations that can be surveyed in Items C2.a–h. Use the Comments area of Section D to provide elevations obtained from the construction plans or drawings. Select "Finished Construction" only when all M&E such as furnaces, water heaters, heat pumps, air conditioners, and elevators and their associated equipment have been installed and the grading around the building is completed.

Item C2. A field survey is required for Items C2.a–h. Most control networks will assign a unique identifier for each benchmark. For example, the National Geodetic Survey uses the Permanent Identifier (PID). For the benchmark utilized, provide the PID or other unique identifier assigned by the maintainer of the benchmark. For GPS survey, indicate the benchmark used for the base station, the Continuously Operating Reference Stations (CORS) sites used for an Online Positioning User Service (OPUS) solution (also attach the OPUS report), or the name of the Real Time Network used.

Also provide the vertical datum for the benchmark elevation. All elevations for the certificate, including the elevations for Items C2.a–h, must use the same datum on which the BFE is based. Show the conversion from the field survey datum used if it differs from the datum used for the BFE entered in Item B9 and indicate the conversion software used. Show the datum conversion, if applicable, in the Comments area of Section D.

For property experiencing ground subsidence, the most recent reference mark elevations must be used for determining building elevations. However, when subsidence is involved, the BFE should not be adjusted.

Note: Enter elevations in Items C2.a–h to the nearest tenth of a foot (nearest tenth of a meter, in Puerto Rico); if data is surveyed to the nearest hundredth, round to the nearest tenth.

Item C2.a. Enter the elevation measured at the top of the bottom floor (excluding the attached garage) indicated by the selected Building Diagram (Item A7). For buildings elevated on a crawlspace, Building Diagrams 8 and 9, enter the lowest elevation of the top of the crawlspace floor in Item C2.a, whether or not the crawlspace has permanent flood openings (flood vents).

Item C2.b. For Building Diagrams 2A through 9 in any flood zone, including Zones B, C, X, and D, enter the elevation measured at the top of the next higher floor (excluding the attached garage) indicated by the selected Building Diagram (Item A7). For buildings requiring more than two floors or levels to be surveyed, such as those with multiple floors or multi-level enclosures, enter the additional surveyed elevations and floor descriptions in the Section D Comments, and clarify which floors are entered as Item C2.a and C2.b.

Item C2.c. For floodplain management compliance, this elevation is required for all Building Diagrams 5 and 6 in V Zones in areas seaward of the LiMWA, and in other areas regulated for coastal flooding hazards. Enter the elevation measured at the bottom of the lowest horizontal structural member of the floor indicated by the selected Building Diagram (Item A7) or the figure below. This elevation can be entered for Building Diagrams 5 and 6 in any flood zone, including Zones B, C, X, and D. For Building Diagrams other than 5 and 6 (if applicable), enter the C2.c elevation as indicated in the figure below. *If this item does not apply to the building, enter "N/A" for not applicable.*

Item C2.d. If there is an attached garage, enter the lowest elevation for top of attached garage slab. (Because elevation for top of attached garage slab is self-explanatory, attached garages are not illustrated in the Building Diagrams.)

Item C2.e. Enter the lowest platform, floor, or ground elevation supporting the lowest electrical, heating, ventilation, plumbing, and air conditioning M&E and other utilities servicing the building, which may be located in an attached garage or enclosure or on an open utility platform. Note that elevations for the M&E items are required regardless of their location. Local floodplain management officials are required to ensure that **all** new M&E servicing the building are protected from flooding. Thus, local officials may require that elevation information for all M&E, including ductwork, be documented on the Elevation Certificate. If the M&E is mounted to a wall, pile, etc., enter the platform elevation of the M&E. Indicate the lowest M&E type and its general location (e.g., on floor inside garage, on platform affixed to exterior wall) in the Comments area of Section D or Section G, as appropriate.

Note: For more guidance on floodplain management compliance for utilities, including M&E, refer to FEMA P-348, *Protecting Building Utility Systems from Flood Damage*. The list of M&E and the elevation requirements for documenting floodplain management compliance are different than the NFIP insurance M&E discount eligibility considerations. See Section H Instructions for additional information.

SECTION C – BUILDING ELEVATION INFORMATION (SURVEY REQUIRED) (Continued)

Item C2.f. Enter the finished Lowest Adjacent Grade (LAG) elevation of the ground, sidewalk, or patio slab next to and in direct contact with the building. For a building in Zone AO, use the natural grade elevation, if available. Indicate whether the natural or finished grade was used. If natural grade was used, attach the source of the information (e.g., a grading plan). For buildings under construction in any flood zone, enter the LAG elevation at the time of the survey. **Note:** Natural grade means the undisturbed natural surface of the ground prior to any excavation or fill.

Item C2.g. Enter the finished Highest Adjacent Grade (HAG) elevation of the ground, sidewalk, or patio slab next to and in direct contact with the building. For a building in Zone AO, use the natural grade elevation if available. Indicate whether the natural or finished grade was used. If natural grade was used, attach the source of the information (e.g., a grading plan). For buildings under construction in any flood zone, enter the HAG elevation at the time of the survey.

Item C2.h. Enter the finished LAG elevation of the lowest ground, sidewalk, or patio slab next to and in direct contact with the structurally-attached-deck supports or stairs structurally attached to the building. For buildings under construction in any flood zone, enter the lowest LAG at the time of the survey.

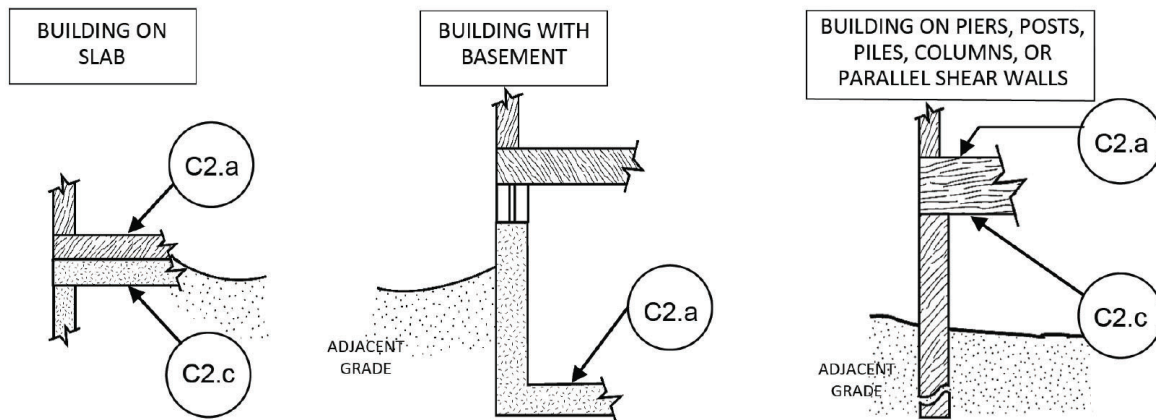

Figures for use in determining Item C2.c

SECTION D – SURVEYOR, ENGINEER, OR ARCHITECT CERTIFICATION

This section of the Elevation Certificate may be signed by only a land surveyor, engineer, or architect who is authorized by state law to certify elevation information. Complete as indicated and place your license number, your seal (as allowed by the state licensing board), your signature, and the date in Section D. You are certifying that the information on this certificate represents your best efforts to interpret the data available and that you understand that any false statement may be punishable by fine or imprisonment under 18 U.S. Code, Section 1001. Use the Comments area of Section D to provide relevant and clarifying information not specified elsewhere on the certificate, including supporting information for latitude/longitude source for A5; openings for A8/A9; LOMR data for Section B; BFE and BFE source data for B9/B10; datum conversion for C2; grading plan for natural grade used in C2.f-g; machinery type and location for C2.e; and any other relevant information identified in the instructions or needed for clarification. If attachments are included, check the attachments box and describe the attachments in the Comments area.

SECTION E – BUILDING MEASUREMENT INFORMATION (SURVEY NOT REQUIRED) FOR ZONE AO, ZONE AR/AO, AND ZONE A (WITHOUT BFE)

Complete Section E if the building is located in Zone AO, Zone AR/AO, or Zone A (without BFE) and the Certificate is being completed for the purpose of documenting compliance with local floodplain management requirements. If the Certificate is being completed to document compliance in other flood zones, including Zone A (with BFE), to support a LOMA, CLOMA, LOMR-F, or CLOMR-F request, or to provide a ground elevation for flood insurance rating, complete Section C instead of Section E. Explain in the Section F Comments area if the measurement provided under Items E1–E4 is not based on the "natural grade." Natural grade means the undisturbed natural surface of the ground prior to any excavation or fill.

Indicate whether the measurements to be entered in this section are based on construction drawings, a building under construction, or finished construction. For either of the first two choices, a post-construction Elevation Certificate will be required when construction is complete. If the building is under construction, include only those measurements that can be determined in Items E1–E4. Use the Comments area of Section F to provide measurements obtained from the construction plans or drawings. Select "Finished Construction" only when all Machinery and Equipment (M&E) such as furnaces, water heaters, heat pumps, air conditioners, and elevators and their associated equipment have been installed and the grading around the building is completed.

Note: Enter heights in Items E1–E4 to the nearest tenth of a foot (nearest tenth of a meter, in Puerto Rico).

Items E1.a and b. Enter in Item E1.a the height of the top of the bottom floor (as indicated by C2.a in the selected Building Diagram, Item A7) above or below the natural HAG. Enter in Item E1.b the height of the top of the bottom floor (as indicated by C2.a in the selected Building Diagram, Item A7) above or below the natural LAG. For buildings in Zone AO, the community's floodplain management ordinance requires the lowest floor of the building be elevated above the HAG at least as high as the base flood depth on the FIRM.

**SECTION E – BUILDING MEASUREMENT INFORMATION (SURVEY NOT REQUIRED)
FOR ZONE AO AND ZONE A (WITHOUT BFE) (Continued)**

Item E2. For Building Diagrams 6–9 with permanent flood openings (see pages 18–19), enter the height of the next higher floor or elevated floor (as indicated by C2.b in the selected Building Diagram, Item A7) above or below the HAG.

Item E3. Enter the height, in relation to the HAG next to the building, for the top of attached garage slab. (Because elevation for top of attached garage slab is self-explanatory, attached garages are not illustrated in the diagrams.) *If this item does not apply to the building, enter "N/A" for not applicable.*

Item E4. Enter the height, in relation to the HAG next to the building, of the platform elevation that supports the M&E servicing the building. See Item C2.e for additional details on M&E. Indicate the M&E type in the Comments area of Section F.

Item E5. For those communities where this base flood depth is not available, the community will need to determine whether the top of the bottom floor is elevated in accordance with the community's floodplain management ordinance.

SECTION F – PROPERTY OWNER (OR OWNER'S AUTHORIZED REPRESENTATIVE) CERTIFICATION

Complete as indicated. This section is provided for certification of measurements when completing Sections A, B, and E. If Section E is completed by a property owner or property owner's authorized representative in Zone AO, AR/AO, or A (without BFE), then the community should confirm the heights in Section E to ensure compliance with community floodplain management ordinances. If Section E is completed by a local floodplain management official, then complete Item G2.a and Section G instead of Section F. The address entered in this section must be the actual mailing address of the individual who provided the information on the certificate. Check the box as indicated if including attachments and describe in the Comments area.

SECTION G – COMMUNITY INFORMATION (RECOMMENDED FOR COMMUNITY OFFICIAL COMPLETION)

The community official who is authorized by law or ordinance to administer the community's floodplain management ordinance can complete Sections A, B, C, E, G or H of this Elevation Certificate and sign this section. Section C may be completed by the local official per the instructions below for Item G1.

Item G1. Check if Section C is completed with elevation data from other documentation that has been signed and sealed by a licensed land surveyor, engineer, or architect who is authorized by state law to certify elevation information. Indicate the source of the elevation data and the date obtained in the Comments area of Section G. If you are both a community official and a licensed land surveyor, engineer, or architect authorized by state law to certify elevation information, and you performed the actual survey for a building in any flood zones (including Zones A99, B, C, X and D), you must also complete Section D.

Item G2.a. Check if information is entered in Section E by the community for a building in Zone A (without a BFE), Zone AO, or Zone AR/AO, or when the community certifies Item E5 for a building in Zone AO.

Item G2.b. Check if information is entered in Section H by the community for insurance purposes.

Item G3. Check if the community official is correcting information provided in Sections A, B, E and H. Describe corrections in the Comments area of Section G.

Item G4. Check if the information in Items G5–G11 has been completed for community floodplain management purposes to document the as-built lowest floor elevation of the building. Section C of the Elevation Certificate records the elevation of various building components but does not determine the lowest floor of the building or whether the building, as constructed, complies with the community's floodplain management ordinance. This must be done by the community. Items G5–G11 provide a way to document these determinations.

Item G5. Permit Number. Enter the permit number or other identifier to key the Elevation Certificate to the permit issued for the building.

Item G6. Date Permit Issued. Enter the date the permit was issued for the building.

Item G7. Date Certificate of Compliance/Occupancy Issued. Enter the date that the Certificate of Compliance or Occupancy or similar written official documentation of as-built lowest floor elevation was issued by the community as evidence that all work authorized by the floodplain development permit has been completed in accordance with the community's floodplain management laws or ordinances.

Item G8. New Construction or Substantial Improvement. Check the applicable box. "Substantial Improvement" means any reconstruction, rehabilitation, addition, or other improvement of a building, the cost of which equals or exceeds 50 percent of the market value of the building before the start of construction of the improvement (or meets the community's more restrictive standards, if applicable). The term includes buildings that have incurred substantial damage, regardless of the actual repair work performed.

Item G9.a. As-built lowest floor elevation. Enter the elevation of the lowest floor (including basement) when the construction of the building is completed and a final inspection has been made to confirm that the building is built in accordance with the permit, the approved plans, and the community's floodplain management laws or ordinances. Indicate the elevation datum used.

Item G9.b. As-built lowest horizontal structural member. Enter the elevation measured at the bottom of the lowest horizontal structural member of the floor indicated by the selected Building Diagram (Item A7) or in the figure at the end of the instructions for Section C. Indicate the elevation datum used.

SECTION G – COMMUNITY INFORMATION (RECOMMENDED FOR COMMUNITY OFFICIAL COMPLETION) (Continued)

Item G10.a. BFE. Using the appropriate FIRM panel, FIS, or other data source, locate the property and enter the BFE (or base flood depth) of the building site. Indicate the elevation datum used.

Item G10.b. Community's minimum elevation or depth requirement. Enter the elevation (including freeboard above the BFE) to which the community requires the lowest floor or the lowest horizontal structural member to be elevated. Indicate the elevation datum used.

Item G11. Indicate Yes if a variance from the floodplain management regulations (Title 44 CFR § 60.6) has been issued for the building, attach the supporting documentation, and describe the attachment in the Comments area of this section. If no such variance has been issued, indicate No.

Enter your name, title, and telephone number, and the name of the community and add any comments. Sign and enter the date in the appropriate blanks.

**SECTION H – BUILDING'S FIRST FLOOR HEIGHT INFORMATION FOR ALL ZONES
(SURVEY NOT REQUIRED) (FOR INSURANCE PURPOSES ONLY)**

In any flood zone the property owner, owner's authorized representative, or local floodplain management official may complete this certificate for rating purposes to determine the building's first floor height and identify the elevation of Machinery and Equipment (M&E) servicing the building. Sections A, B, and I must also be completed.

Note: If Sections C and/or E and H are all completed, then information in Section C will prevail for insurance purposes and for compliance.

Item H1.a. For Building Diagrams 1A, 1B, 3, and 5–9 shown on pages 17–19, enter in Item H1.a the height to the nearest tenth of a foot (tenth of a meter in Puerto Rico) of the top of the bottom floor (as indicated in the selected Building Diagram, Item A7) above the LAG. Refer to the arrows on the Foundation Type Diagrams on page 16 that indicate which floor to use to determine the height for Item H1.a.

Item H1.b. For Building Diagrams 2A, 2B, 4, and 6–9 shown on pages 17–19, enter in Item H1.b the height to the nearest tenth of a foot (tenth of a meter in Puerto Rico) of the top of the next higher floor or elevated floor (as indicated in the selected Building Diagram, Item A7) above the LAG. Refer to the arrows on the Foundation Type Diagrams on page 16 that indicate which floor to use to determine the height for Item H1.b.

Note: The LAG is the lowest point of the ground level immediately next to a building.

Item H2. Indicate "Yes" if **all** of the following M&E servicing the building, inside or outside the building, are elevated to at least the height of the location shown by the H2 arrow in the Foundation Type Diagrams on page 16: central air conditioner (including exterior compressor), furnace, heat pump (including exterior compressor), water heater, and elevator M&E. For contents-only insurance coverage, **all** of the following appliances will need to be elevated to at least the height of the location shown by the H2 arrow in the Foundation Type Diagrams below: clothes washers and dryers and food freezers.

Note: For both building and contents coverage, **all** of the M&E and appliances listed above must be elevated per the Foundation Type Diagrams on page 16 to be considered for the M&E mitigation discount.

Indicate "No" if any of the M&E listed above is not elevated to at least the height of the location shown by the H2 arrow in the Foundation Type Diagrams on page 16.

The diagrams on the following page illustrate the six NFIP Foundation Type Diagrams. Each foundation type corresponds with one or more of the eleven Building Diagrams shown at the end of this Elevation Certificate. The arrows on the diagrams indicate which floor to use to determine H1.a and H1.b The arrows marked as H2 show the minimum elevation required to be eligible for the M&E mitigation discount.

SECTION I – PROPERTY OWNER (OR OWNER'S AUTHORIZED REPRESENTATIVE) CERTIFICATION

Complete as indicated. This section is provided for certification of measurements when completing Sections A, B, and H. If Section H is completed by a local floodplain management official, then complete Item G2.b and Section G instead of Section I. The address entered in this section must be the actual mailing address of the individual who provided the information on the certificate.

Check the box as indicated if including attachments (e.g., required photos) and describe in the Comments area.

Foundation Type Diagrams (for use in Section H):

Slab on Grade (Non-Elevated)



Corresponds to EC Diagrams 1A, 1B and 3

Note: If the building has more than one floor, the Machinery and Equipment should be on the second floor or higher.

Elevated without Enclosure on Posts, Piles, or Piers

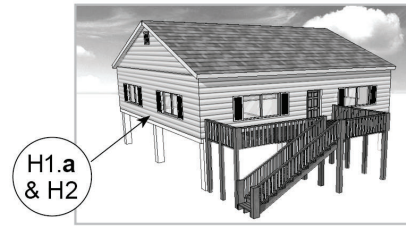

Corresponds to EC Diagram 5

Basement (Non-Elevated)

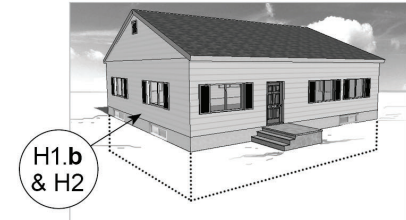

Corresponds to EC Diagrams 2A, 2B and 4

Elevated with Enclosure on Posts, Piles, or Piers



Corresponds to EC Diagram 6

Crawlspace (Elevated, including Non-Elevated Sub-Grade Crawlspace)



Corresponds to EC Diagrams 8 and 9

Elevated with Enclosure Not on Posts, Piles, or Piers (Solid Foundation Walls)



Corresponds to EC Diagram 7

BUILDING DIAGRAMS

The following diagrams illustrate various types of buildings. Compare the features of the building being certified with the features shown in the diagrams and select the diagram most applicable. Enter the diagram number in Item A7, the square footage of crawlspace or enclosure(s) and the area of flood openings as indicated in Items A8.a-f, the square footage of attached garage and the area of flood openings as indicated in Items A9.a-f, and the elevations in Items C2.a-h.

In A, B, C, X and D zones, the floor elevation is taken at the top finished surface of the floor indicated; in V zones, areas seaward of the LiMWA, and in other areas regulated for coastal flooding hazards, the floor elevation is taken at the bottom of the lowest horizontal structural member (see figure at end of instructions for Section C).

DIAGRAM 1A:

All slab-on-grade single- and multiple-floor buildings (other than split-level) and high-rise buildings, either detached or row type (e.g., townhouses); with or without attached garage.

Distinguishing Feature – The bottom floor is at or above ground level (grade) on at least one side.*

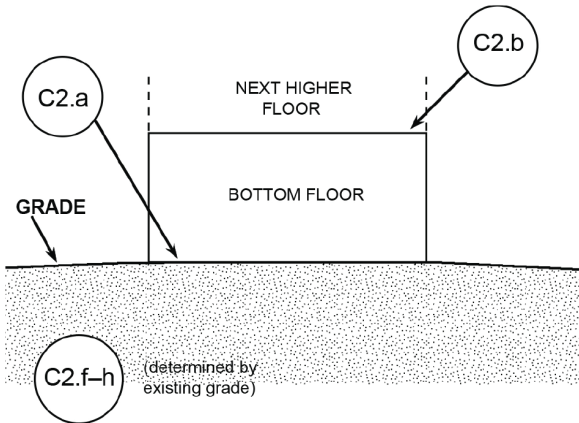

DIAGRAM 1B:

All raised-slab-on-grade or slab-on-stem-wall-with-fill single- and multiple-floor buildings (other than split-level), either detached or row type (e.g., townhouses); with or without attached garage.

Distinguishing Feature – The bottom floor is at or above ground level (grade) on at least one side.*

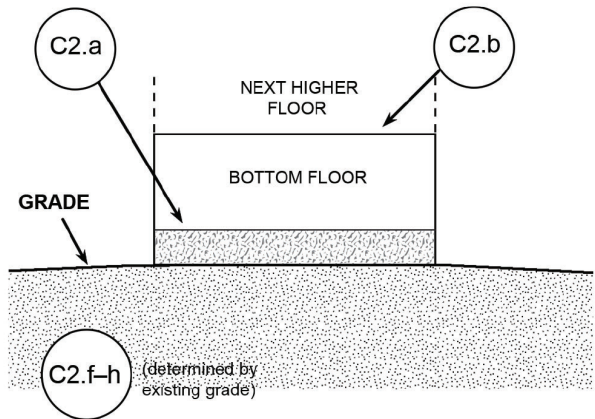

DIAGRAM 2A:

All single- and multiple-floor buildings with basement (other than split-level) and high-rise buildings with basement, either detached or row type (e.g., townhouses); with or without attached garage.

Distinguishing Feature – The bottom floor (basement or underground garage) is below ground level (grade) on all sides.*

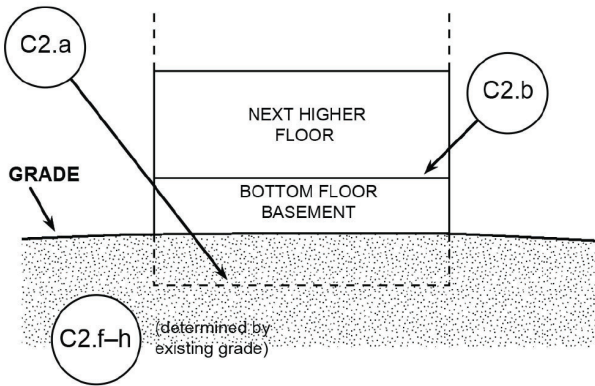
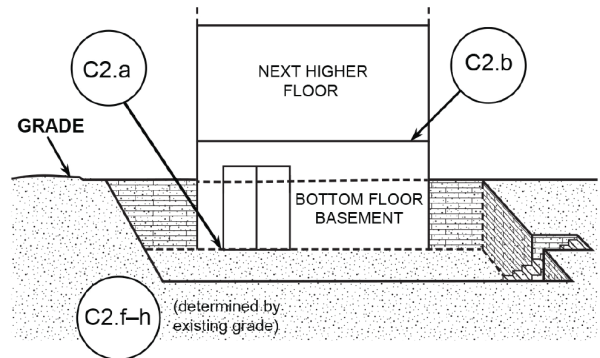

DIAGRAM 2B:

All single- and multiple-floor buildings with basement (other than split-level) and high-rise buildings with basement, either detached or row type (e.g., townhouses); with or without attached garage.

Distinguishing Feature – The bottom floor (basement or underground garage) is below ground level (grade) on all sides; most of the height of the walls is below ground level on all sides; and the door and area of egress are also below ground level on all sides.*



* A floor that is below ground level (grade) on all sides is considered a basement even if the floor is used for living purposes, or as an office, garage, workshop, etc.

BUILDING DIAGRAMS

DIAGRAM 3:

All split-level buildings that are slab-on-grade, either detached or row type (e.g., townhouses); with or without attached garage.

Distinguishing Feature – The bottom floor (excluding garage) is at or above ground level (grade) on at least one side.*

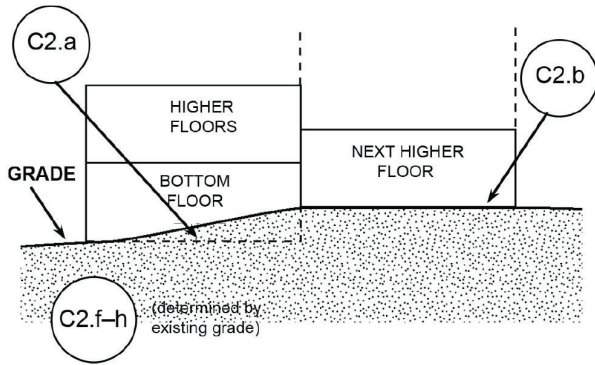

DIAGRAM 4:

All split-level buildings (other than slab-on-grade), either detached or row type (e.g., townhouses); with or without attached garage.

Distinguishing Feature – The bottom floor (basement or underground garage) is below ground level (grade) on all sides.*

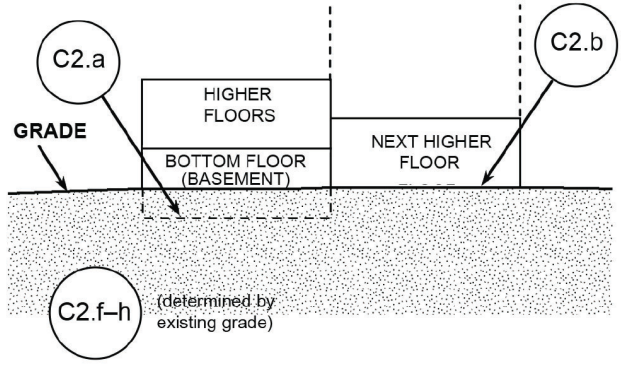

DIAGRAM 5:

All buildings elevated on piers, posts, piles, columns, or parallel shear walls. No obstructions below the elevated floor.

Distinguishing Feature – For all zones, the area below the elevated floor is open, with no obstruction to flow of floodwaters (open lattice work and/or insect screening is permissible).

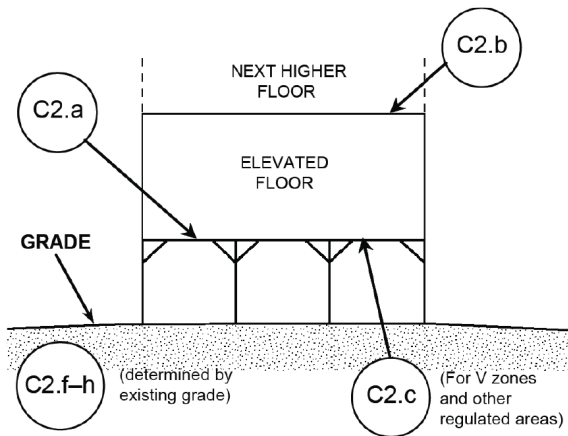
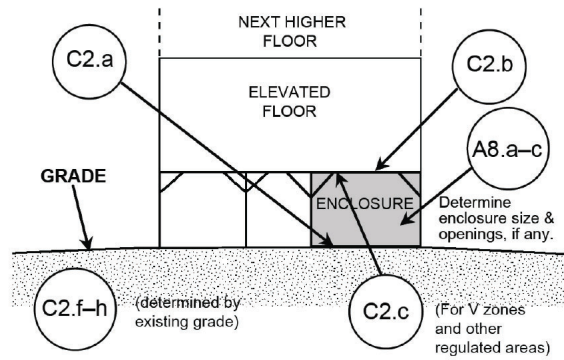

DIAGRAM 6:

All buildings elevated on piers, posts, piles, columns, or parallel shear walls with full or partial enclosure below the elevated floor.

Distinguishing Feature – For all zones, the area below the elevated floor is enclosed, either partially or fully. In A Zones, the partially or fully enclosed area below the elevated floor is with or without openings** present in the walls of the enclosure. Indicate information about enclosure size and openings in Section A - Property Information.



* A floor that is below ground level (grade) on all sides is considered a basement even if the floor is used for living purposes, or as an office, garage, workshop, etc.

** An "opening" is a permanent opening that allows for the free passage of water automatically in both directions without human intervention. Under the NFIP, a minimum of two openings is required for enclosures or crawlspaces. The openings shall provide a total net area of not less than one square inch for every square foot of area enclosed, excluding any bars, louvers, or other covers of the opening. Alternatively, an Individual Engineered Flood Openings Certification or an Evaluation Report issued by the ICC ES must be submitted to document that the design of the openings will allow for the automatic equalization of hydrostatic flood forces on exterior walls. A window, a door, or a garage door is not considered an opening; openings may be installed in doors. Openings shall be on at least two sides of the enclosed area. If a building has more than one enclosed area, each area must have openings to allow floodwater to directly enter. The bottom of the openings must be no higher than 1.0 foot above the higher of the exterior or interior grade or floor immediately below the opening. For more guidance on openings, see NFIP Technical Bulletin 1.

BUILDING DIAGRAMS

DIAGRAM 7:

All buildings elevated on full-story foundation walls with a partially or fully enclosed area below the elevated floor. This includes walkout levels, where at least one side is at or above grade. The principal use of this building is located in the elevated floors of the building.

Distinguishing Feature – For all zones, the area below the elevated floor is enclosed, either partially or fully. In A Zones, the partially or fully enclosed area below the elevated floor is with or without openings** present in the walls of the enclosure. Indicate information about enclosure size and openings in Section A - Property Information.

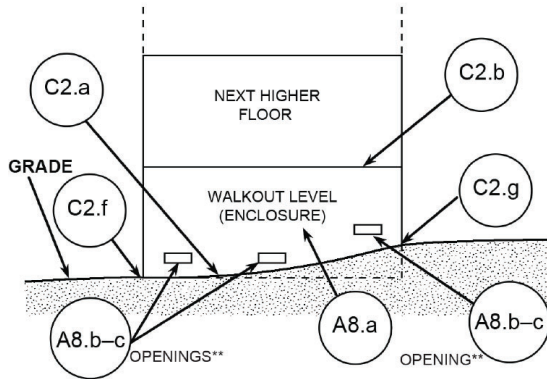

DIAGRAM 8:

All buildings elevated on a crawlspace with the floor of the crawlspace at or above grade on at least one side, with or without an attached garage.

Distinguishing Feature – For all zones, the area below the first floor is enclosed by solid or partial perimeter walls. In all A zones, the crawlspace is with or without openings** present in the walls of the crawlspace. Indicate information about crawlspace size and openings in Section A - Property Information. (If the distance from the crawlspace floor to the top of the next higher floor is more than 5 feet, use Diagram 7.)

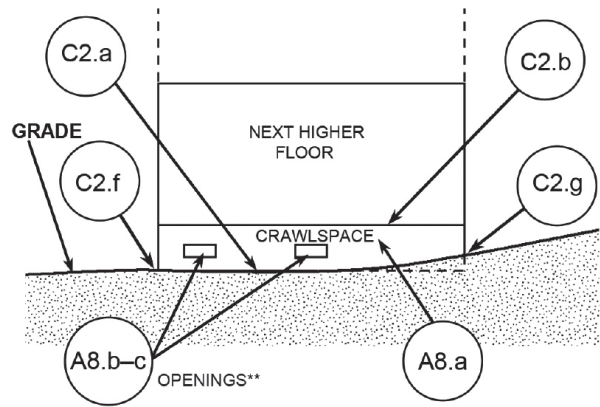
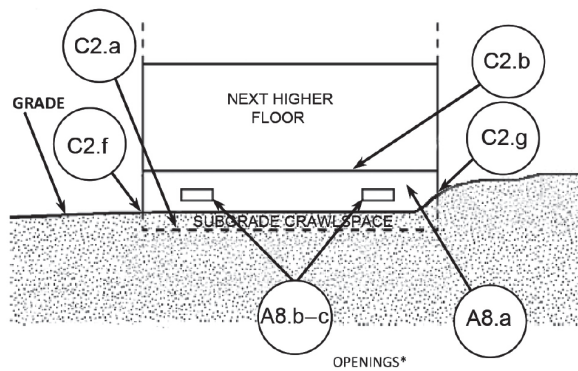

DIAGRAM 9:

All buildings (other than split-level) elevated on a sub-grade crawlspace, with or without attached garage.

Distinguishing Feature – The bottom (crawlspace) floor is below ground level (grade) on all sides.* (If the distance from the crawlspace floor to the top of the next higher floor is more than five feet, or the crawlspace floor is more than two feet below the grade [LAG] on all sides, use Diagram 2A or 2B.)



* A floor that is below ground level (grade) on all sides is considered a basement even if the floor is used for living purposes, or as an office, garage, workshop, etc.

** An "opening" is a permanent opening that allows for the free passage of water automatically in both directions without human intervention. Under the NFIP, a minimum of two openings is required for enclosures or crawlspaces. The openings shall provide a total net area of not less than one square inch for every square foot of area enclosed, excluding any bars, louvers, or other covers of the opening. Alternatively, an Individual Engineered Flood Openings Certification or an Evaluation Report issued by the ICC ES must be submitted to document that the design of the openings will allow for the automatic equalization of hydrostatic flood forces on exterior walls. A window, a door, or a garage door is not considered an opening; openings may be installed in doors. Openings shall be on at least two sides of the enclosed area. If a building has more than one enclosed area, each area must have openings to allow floodwater to directly enter. The bottom of the openings must be no higher than 1.0 foot above the higher of the exterior or interior grade or floor immediately below the opening. For more guidance on openings, see NFIP Technical Bulletin 1.